

# GU 10 - 11 GIUNTO MULTIPRESA

1	2	3	4	5	GU 11
Corpo Body Corps Körper	Otturatore Valve Clapet Ventil	Molle Springs Ressorts Feder	Guarnizioni Seals Joint d'étanchéité Dichtung	Sfere Balls Billes Kugel	Innesti Plugs Embouts Stecker
Ottone UNI EN 12164 CW614N Nichelato Brass UNI EN 12164 CW614N Nickel plated Laiton UNI EN 12164 CW614N Nickelé Ms Vernickelt UNI EN 12164 CW614N	Ottone UNI EN 12164 CW614N Nichelato Brass UNI EN 12164 CW614N Nickel plated Laiton UNI EN 12164 CW614N Nickelé Ms Vernickelt UNI EN 12164 CW614N	Acciaio Inox AISI 302 Stainless Steel AISI 302 Acier Inox AISI 302 Edelstahl AISI 302	NBR NBR NBR NBR	Acciaio Inox AISI 420 Stainless Steel AISI 420 Acier Inox AISI 420 Edelstahl AISI 420	Acciaio Nichelato Nickel plated steel Acier Nickelé Stahl Vernickelt

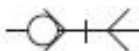
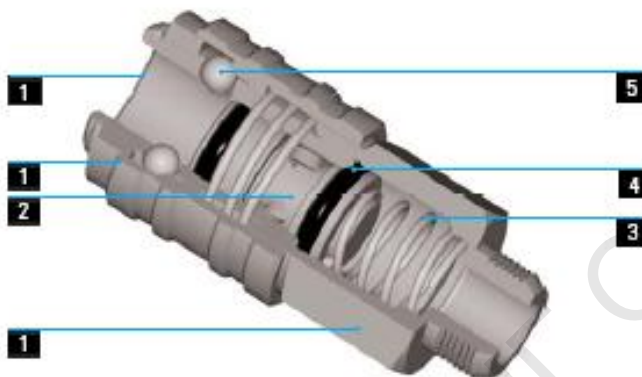

Intercambiabilità con i profili  
Suitable with following plugs profiles  
Interchangeable avec les suivants profils  
Austauschbar mit folgenden Profilen

Portata a 6 bar  
Flow rate at 6 bar  
Débit à 6 bar  
Durchfluß (6 bar)



Profilo Europeo  
European Profile  
Profil européen  
Europäisches Profil

1600 NI/min

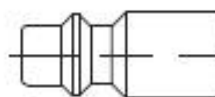

Profilo ISO 6150 B  
ISO 6150 B Profile  
Profil ISO 6150 B  
ISO 6150 B Profil

1280 NI/min

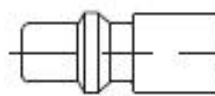

Profilo Svedese  
Standard Swedish Profile  
Profil Standard Suédois  
Standard schwedisches Profil

1280 NI/min

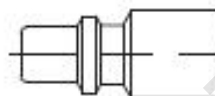

Profilo Italiano  
Standard Italian Profile  
Profil Standard Italien  
Standard Italienisches Profil

1080 NI/min

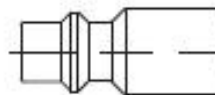

Profilo MIL C4109  
MIL C4109 Profile  
Profil MIL C4109  
MIL C4109 Profil

1310 NI/min

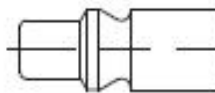

Profilo ARD 210  
ARD 210 Profile  
Profil ARD 210  
ARD 210 Profil

1160 NI/min

Scala 1:1 - Scale 1:1 - Echelle 1:1 - Maßstab 1:1

GIUNTO MULTIPRESA

MULTI PROFILE QUICK COUPLER

COUPLEUR MULTIPROFIL

MULTIPROFILKUPPLUNG

Pressione di esercizio: 0 ÷ 15 bar  
Temperatura di esercizio: -20°C ÷ 70°C

Working pressure: 0 ÷ 15 bar  
Working temperature: -20°C ÷ 70°C

Pression de service: 0 ÷ 15 bar  
Températures de service: -20°C ÷ 70°C

Druckbereich: 0 ÷ 15 bar  
Temperaturbereich: -20°C ÷ 70°C

## GU 10-11

Giunto con filetto maschio

Male coupling

Coupleur mâle

Einschraubkupplung

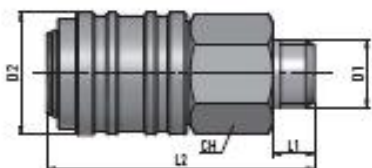

Tipo	D <sub>1</sub>	D <sub>2</sub>	L <sub>1</sub>	L <sub>2</sub>	CH	g
11 00 14	G1/4	23,5	10	52	20	98
11 00 38	G3/8	23,5	11	52	20	92
11 00 12	G1/2	23,5	11	52	24	118

## GU 10-12

Giunto con filetto femmina

Female coupling

Coupleur femelle

Aufschraubkupplung

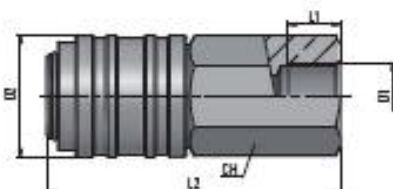

Tipo	D <sub>1</sub>	D <sub>2</sub>	L <sub>1</sub>	L <sub>2</sub>	CH	g
12 00 14	G1/4	23,5	10	57	20	109
12 00 38	G3/8	23,5	11	58	20	104
12 00 12	G1/2	23,5	11	60	24	134

## GU 10-13

Giunto con portagomma

Coupling with hose connection

Coupleur avec douille cannelée

Kupplung mit Schlauchdüse

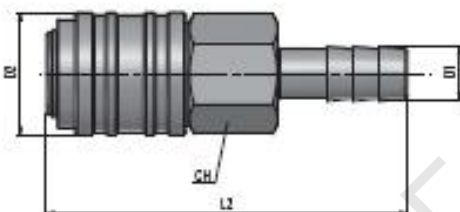

Tipo	Ø Tubo	D <sub>1</sub>	D <sub>2</sub>	L <sub>1</sub>	CH	g
13 06 00	6	7,5	23,5	70	20	92
13 09 00	9	10,5	23,5	70	20	93
13 13 00	13	14,5	23,5	70	20	107

## GU 11-20

Innesto Italia con filetto maschio

Male plug, Italian profile

Embout mâle, profil italien

Einschraubverschlußnippel,  
italienisches Profil

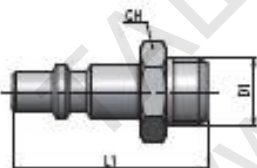

Tipo	D <sub>1</sub>	L <sub>1</sub>	CH	g
20 00 14	G1/4	37,5	14	17
20 00 38	G3/8	40	19	28
20 00 12	G1/2	40,5	24	43

## GU 11-21

Innesto Italia con filetto femmina

Female plug, Italian profile

Embout femelle, profil italien

Aufschraubverschlußnippel,  
italienisches Profil

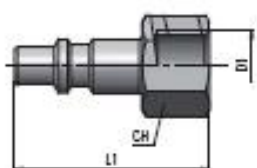

Tipo	D <sub>1</sub>	L <sub>1</sub>	CH	g
21 00 14	G1/4	39	17	23
21 00 38	G3/8	41	19	26